

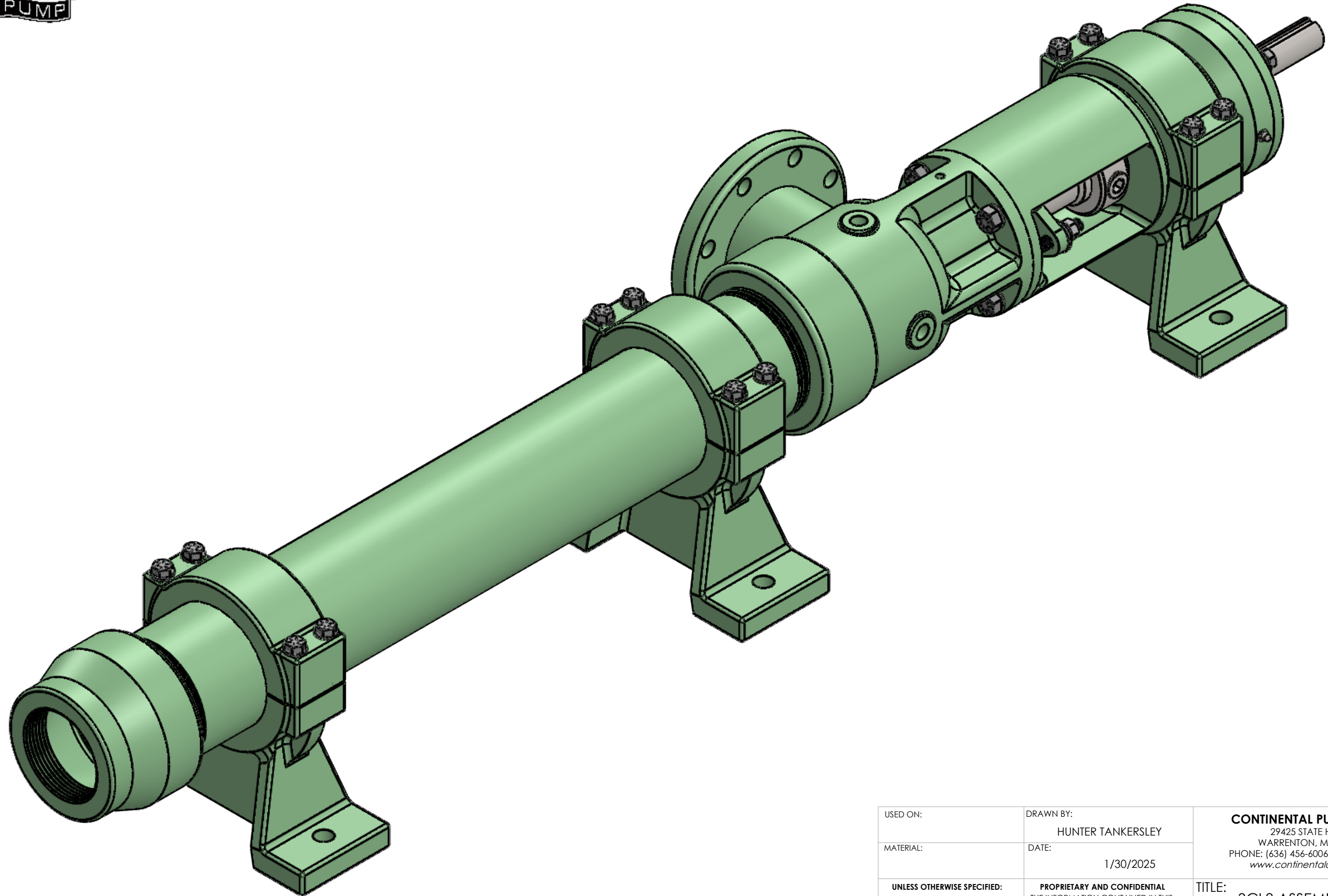

SUCTION ROTATED 90 DEGREES

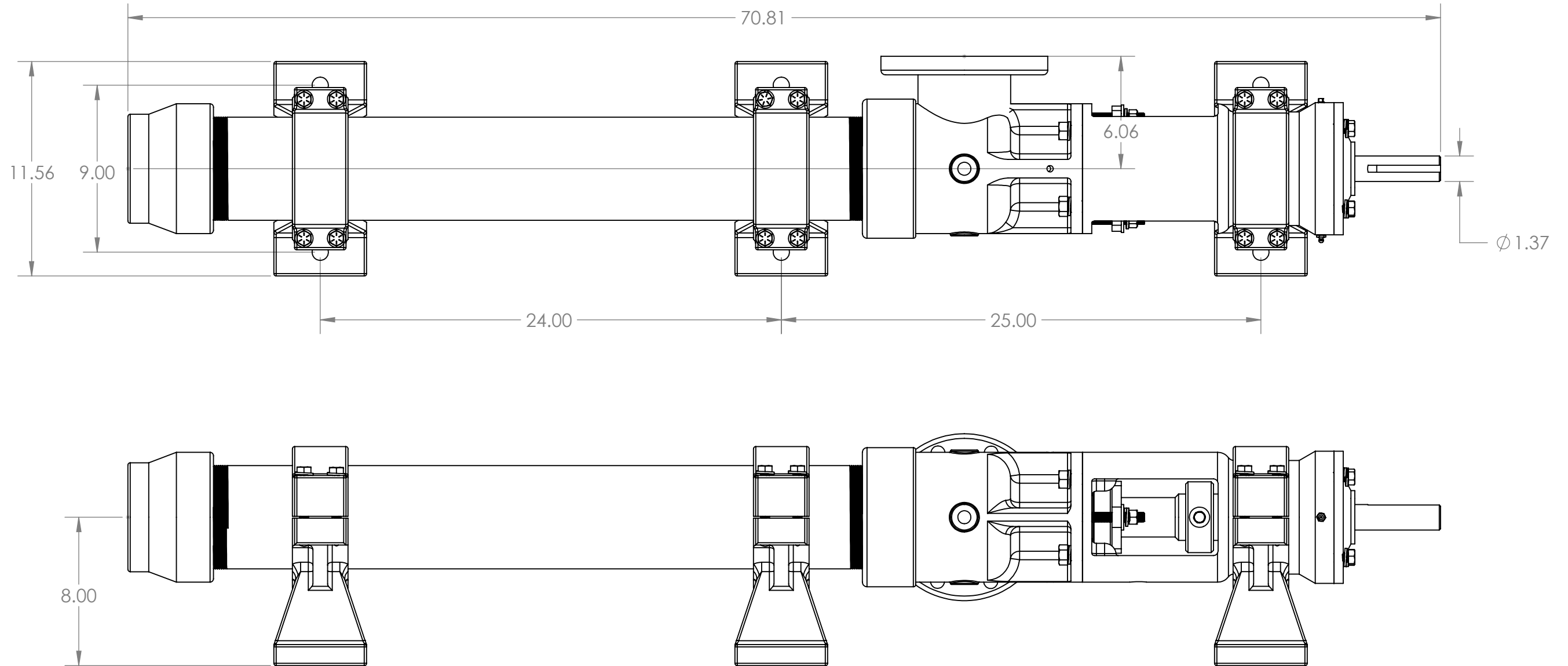

USED ON:	DRAWN BY: HUNTER TANKERSLEY	CONTINENTAL PUMP COMPANY 29425 STATE HIGHWAY B WARRENTON, MISSOURI 63383 PHONE: (636) 456-6006 FAX: (636) 456-4337 www.continentalultrapumps.com						
MATERIAL:	DATE: 1/30/2025							
UNLESS OTHERWISE SPECIFIED: DIMENSIONS ARE IN INCHES TOLERANCES: FRACTIONAL ± ANGULAR: MACH ± BEND ± TWO PLACE DECIMAL ± THREE PLACE DECIMAL ±	PROPRIETARY AND CONFIDENTIAL THE INFORMATION CONTAINED IN THIS DRAWING IS THE SOLE PROPERTY OF CONTINENTAL PUMP COMPANY. ANY REPRODUCTION IN PART OR AS A WHOLE WITHOUT THE WRITTEN PERMISSION OF CONTINENTAL PUMP COMPANY IS PROHIBITED.	TITLE: 3CL8 ASSEMBLY DRAWING						
		<table border="1"> <tr> <td>SIZE</td> <td>DWG. NO.</td> <td>REV</td> </tr> <tr> <td></td> <td></td> <td>-</td> </tr> </table>	SIZE	DWG. NO.	REV			-
SIZE	DWG. NO.	REV						
		-						
		DO NOT SCALE DRAWING SHEET 1 OF 2						



**SUCTION SIZE - 4" 150# FLANGE
DISCHARGE SIZE - 4" NPT**

USED ON:	DRAWN BY: HUNTER TANKERSLEY	CONTINENTAL PUMP COMPANY 29425 STATE HIGHWAY B WARRENTON, MISSOURI 63383 PHONE: (636) 456-6006 FAX: (636) 456-4337 www.continentalultrapumps.com	
MATERIAL:	DATE: 1/30/2025		
UNLESS OTHERWISE SPECIFIED: DIMENSIONS ARE IN INCHES TOLERANCES: FRACTIONAL ± ANGULAR: MACH ± BEND ± TWO PLACE DECIMAL ± THREE PLACE DECIMAL ±	PROPRIETARY AND CONFIDENTIAL THE INFORMATION CONTAINED IN THIS DRAWING IS THE SOLE PROPERTY OF CONTINENTAL PUMP COMPANY. ANY REPRODUCTION IN PART OR AS A WHOLE WITHOUT THE WRITTEN PERMISSION OF CONTINENTAL PUMP COMPANY IS PROHIBITED.	TITLE: 3CL8 ASSEMBLY DRAWING	
	SIZE	DWG. NO.	REV -
DO NOT SCALE DRAWING		SHEET 2 OF 2	